

Eaton®
Commercial Controls Division

Heinemann® Circuit Breakers

The Power of Reliability



EATON

For the Widest Selection of Circuit Protection, from 0.01 to 1200 Amperes, Look to HEINEMANN

Circuit Breaker Selection Guide

Before You Make a Decision

Choosing the right circuit protector for a particular application shouldn't be left to chance. While the selection process may range from simple to complex, this handy guide will get you started. HEINEMANN technical assistance engineers are ready to help you make the final decisions wisely and economically.

Refer to pages 8 and 9 for internal circuits regarding protective and control applications.

Refer to pages 10 and 11 for construction codes.

HEINEMANN offers the widest selection of overcurrent protectors for end products as diverse as electronic data processing and industrial air conditioning to marine craft and military equipment. We are also able to supply breakers that serve as control functions, giving you the performance of an ON/OFF switch and a circuit breaker, all in one economical and compact unit.

This condensed guide will assist you with product selection, helping you review options for your specific application. You may also call one of our applications engineers to discuss your particular requirement. We may have already solved your particular problem for someone else. If not, we'll develop a circuit protector to suit your needs.

NOTICE!

"The use of Eaton Corporation, Commercial Controls Division apparatus should be in accordance with the provisions of the National Electrical Code, UL and/or other local, military or industry standards that are pertinent to the particular end use. Installation or use not in accordance with these codes and standards could be hazardous to personnel and/or equipment."

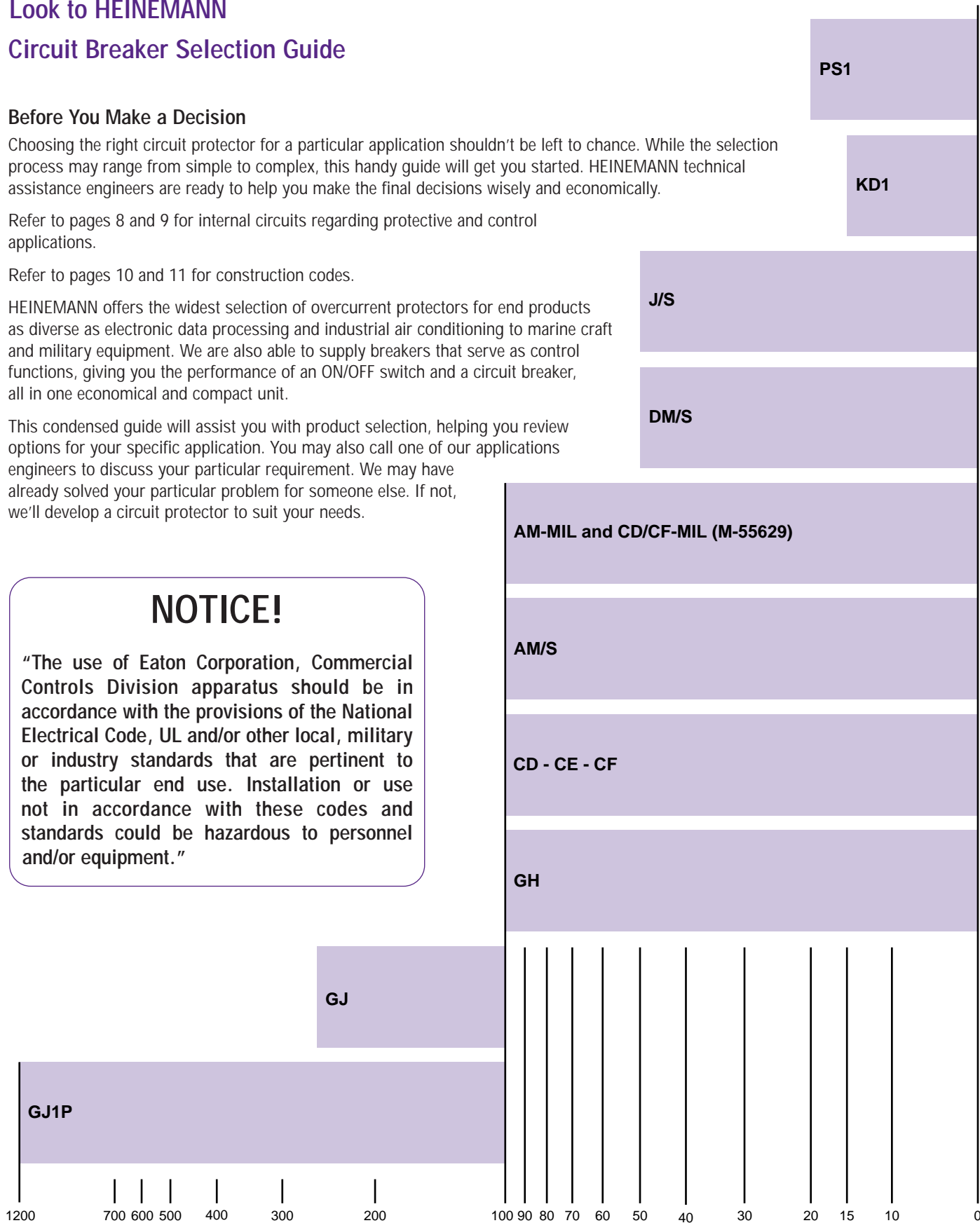

Series PS1



Series KD1



Fuse-switch provides ON/OFF control and fuse protection in a single low-cost component. Its use eliminates a hole and interconnecting wiring and makes it easy to re-fuse from the front panel. It accepts standard 1/4" diameter by 1-1/4" fuses. An adapter is available for 5 mm x 20 mm fuses. Can be supplied for NO or NC operation.

A low cost pushbutton supplementary protector for electrical equipment, designed to fit in a standard 5/8" round or "D" fuseholder panel cutout. Resettable at up to 1000% of its rated current from 2.5A through 15A, 500% from 0.25A through 2A. Slide-on retaining ring included.

Applications — Consumer and industrial products that would otherwise use a separate ON/OFF switch and fuse holder.

Consumer and industrial products, office machines, appliances, power supplies, convenience outlets, electronic games.

No. of Poles —

1

Current Ratings — Determined by choice of fuse. To 20A

0.25 – 15A

Max. Voltage —

120V AC @ 20A
250V AC @ 15A
32V DC @ 20A
240V AC @ 15A

250V AC, 50/60 Hz
50V AC up to 10A
32V DC @ 15A
50V DC @ 10A

Interrupting Capacity —

1000A @ 250V AC, 50/60 Hz
200A @ 32V DC and 50V DC per UL Standard 1077 testing procedures

Agency Recognition or Approval —

UL recognized
CSA certified
SEV approved

UL recognized (Std. 1077)
CSA certified
VDE approved
SEV approved

Dimensions —

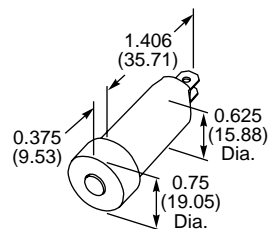
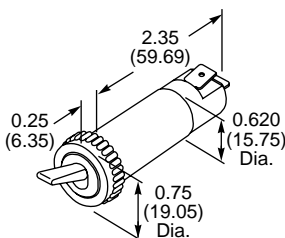

Series J/S



Compact, lightweight, moderately priced circuit breaker for single- or multi-pole OEM applications. Also available with snap-in mounting or rocker handles. Sealed mount models are also available, single-pole only. Series J/S breakers are suitable for domestic or world-market applications. Models also available for marine applications.

OEM (power supplies, medical-electronic equipment, control systems, office and EDP equipment), control panels, marine equipment, field instrumentation.

1 to 6

0.02 – 50A

250V AC (30A maximum)
65V DC (50A maximum)
80V DC (15A maximum)

1000A
5000A with back-up fusing

UL recognized (Std. 1077)
CSA certified
SEV approved
IEC approved
VDE approved
UL listed (Std. UL489)

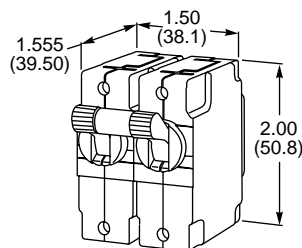

Series DM/S



DM/S circuit breakers snap easily into a standard 35 mm DIN rail and may be mounted or detected without moving other breakers on the rail. They provide all the advantages of hydraulic-magnetic circuit protection including freedom from heat-induced nuisance tripping and a wide choice of time delay ranges. Available with auxiliary SPDT switch for alarm or control purposes.

OEM (industrial equipment, process control systems and telecommunications).

1 to 4

0.02 – 50A

250V, 50/60 or 400 Hz
277V, 50/60 Hz, 1-pin
480V, 50/60 Hz, 3-pin "Y"
65V DC

1000A
5000A with back-up fusing

UL recognized (Std. 1077)
CSA certified
SEV approved
IEC approved
VDE approved

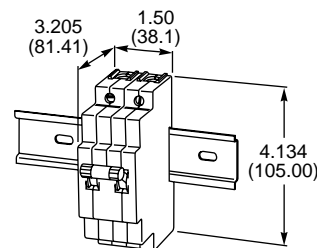

Series GH



This rugged EH-frame breaker offers all the advantages of a completely magnetic, three-pole breaker with 10,000A interrupting capacity for a less costly, smaller circuit breaker. Compact, environmentally stable. To 100A at 480V AC and 250V DC.

Motor controls, air conditioning, electric heating, computer mainframes, transportation, indoor or outdoor installations.

1 to 4

0.5 – 100A (AC)
0.5 – 100A (DC)

480V, 50/60 Hz
750V DC
600V AC

14,000A (AC)
10,000A (DC)

UL recognized (AC)
(3 pole)
480V AC
15 – 100A

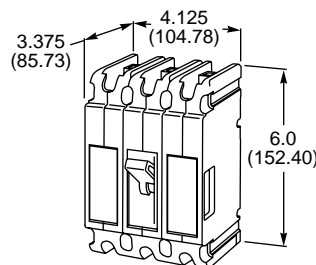

Series GJ



Where space is at a premium and current capacity up to 250A is called for, the Series GJ is the answer. Available in 1, 2 or 3 pole models, it is especially suitable for panelboards, service entrances and electric vehicles.

Commercial, industrial, and residential service — entrance or panelboard applications, lighting, appliance, transformer, electric vehicles, EDP power supplies, heating, air conditioning and electronic circuit protection.

1 to 6

100 – 250A

240V, 50/60 Hz
125/250V DC

18,000A @ 240V, 50/60 Hz
10,000A @ 125/250V DC
14,000A @ 160V DC
25,000A @ 65V DC

240V, 50/60 Hz and
125/250V DC: UL listed

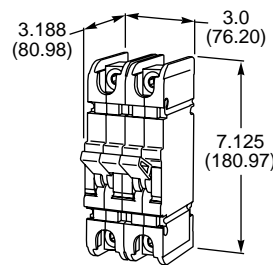

Series GJ1P



GJ1P parallel-pole breakers incorporate Precision Current Equalization (PCE) to automatically distribute current sensing elements. PCE thereby minimizes nuisance tripping which can occur with conventional parallel-pole breakers. An optional shunt permits metering of current. Since shunt output is only 25 mV, light-gauge wiring can be used between shunt and meter.

Telecommunications and transportation equipment.

1

100 – 1200A (DC)

160V DC

10,000A @ 160V DC
25,000A @ 65V DC

160V DC: UL listed

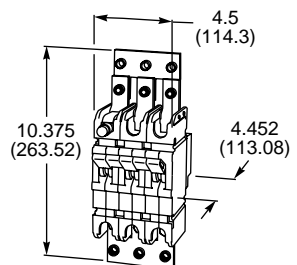

Precise Overload Protection — with HEINEMANN Hydraulic-Magnetic Circuit Breakers

Heat-Induced Nuisance Tripping Eliminated

HEINEMANN hydraulic-magnetic circuit breakers offer three major advantages over thermal devices.

1. Elimination of nuisance tripping caused by high ambient temperatures in or near the installation. The breaker responds only to current variations, not to temperature change.
2. Assurance that 100% of the rated current will be carried. There is no such assurance with thermal devices, which may fail to carry rated current when subjected to above-normal ambient temperatures. A HEINEMANN breaker rated at 20A, for example, will sustain 20A, even at elevated temperatures. Derating and other forms of temperature compensation are unnecessary.
3. Immediate reset. Since there are no thermal elements, heat build-up is not a factor. Therefore, no "cooling off" period is required after fault interruption.

Time Delay Eliminates Breaker Tripping Due to Transient Current Surges

Elimination of transient current surges as a cause of nuisance tripping is accomplished through the creation of a controlled

time delay. In any installation where a power supply or compressor motor is on the line, an inrush of current occurs when the equipment is first turned on. The bigger the equipment, the larger the surge. Although inrush surges are, in fact, transient overloads, they usually pose no threat of damage to the line or the equipment. So, it is not necessary or even desirable to interrupt the power when they occur.

The hydraulically-controlled time-delay mechanism of a HEINEMANN breaker eliminates nuisance tripping without reducing overload protection. The delay is inversely proportional to the overload; response is quicker on large overloads, where greater potential danger exists, and slower on small overloads. Except in special high-inrush models, heavy overload and short-circuit currents of greater than 10 times the breaker's rating provide instantaneous response. (An instantaneous-trip breaker is available for use on, for example, modern medical and communication equipment, which cannot tolerate even brief overloads.)

For added protection, the time-delay is self-adjusting to ambient temperature conditions. At high ambients, where the overload tolerance of most circuits is lowered, the viscosity of the special fluid in the breaker's dashpot is lessened, and the time-delay response is thereby shortened. At low temperatures, the response is correspondingly longer to allow for cold equipment startups.

The Hydraulic-Magnetic Principle (how the breaker works)



1. The HEINEMANN hydraulic-magnetic circuit breaker operates on load-current-produced magnetic flux variation in a solenoid. The coil is wound around a hermetically sealed, non-magnetic tube containing a spring-loaded, movable iron core and a silicone liquid fill. With the load current either at or below the breaker's nominal rating, the magnetic flux is of insufficient strength to move the core, and it remains at the end of the tube opposite the armature.
2. On an overload, the magnetic flux force increases, pulling the iron core into the coil toward the armature end of the tube. This core insertion reduces the reluctance of the magnetic circuit and further increases the strength of the magnetic field. The silicone liquid regulates the core's speed of travel, creating a controlled trip delay that is inversely proportional to the magnitude of the overload. If the overload subsides before the core reaches the pole piece, the core returns to its original position, and the breaker does not trip. (For non-delay applications, the breaker is modified to omit the intentional delay.)
3. When the magnetic flux reaches a predetermined value, the armature is attracted to the pole piece and the breaker trips. (The breaker may trip before the core reaches the pole piece if the critical flux value is achieved first.) On very heavy overloads or short circuits, the flux produced by the coil above, regardless of core position, is sufficient to pull in the armature. This circuit interruption occurs with no intentional delay — a highly desirable response characteristic.

Current Rating and Time Delay is Supplied to User Specification

The current rating of a HEINEMANN breaker is determined by the number of ampere-turns in the load-sensing coil. By altering the number of turns and wire size, HEINEMANN can provide a breaker of virtually any rating within the unit's overall range. It is even possible to specify current ratings in fractional values.

Time-delay characteristics can be precisely matched to the requirements of the application. A choice of many time-delay curves, including non-time-delay and high-inrush protection, is available on most single- and multi-pole breakers.

A Look Inside

1. Broad Selection of Terminal Styles

Pressure connector, threaded stud, hook, bus, plug-in and quick-connect terminals (with holes for optional soldering) are available.

2. Self-Cleaning Contacts

Sliding pivot point causes a wiping action across the contacts each time a breaker is switched. This cleaning motion helps keep surface resistance low, extending contact life. (Contacts are made of silver alloy for minimal wattage loss.)

3. Efficient Blowout Grid

U-shaped grid plates quickly draw out, fragment and extinguish contact arc. Charring and pitting are minimized.

4. Sturdy Toggle and Latch

Strong, durable and highly efficient. Latch is shock-resistant, yet provides very fast operation. Trip-free construction makes it impossible to hold the breaker closed against a fault. (Even when handle is held in ON position, contacts trip free of fault condition.)

5. Balanced Armature

Counterbalanced armature design helps prevent mechanical tripping caused by shock and vibration. Meets MIL-STD-202 requirements.

6. Two-Position Switching

Two handle positions, ON and OFF (no ambiguous "reset" position). After fault clearance, simply snap the handle back to ON.

7. Load-Sensing Coil

Magnetic unit measures current, not temperature, making it unnecessary to derate for high-ambient service. Coil will carry 100% rated load as specified in the appropriate response curve. (See in-depth discussion, page 6.)

8. Fungus-Resistant Case

Circuit breakers are housed in special plastic casings that significantly reduce fungal growth and contamination.

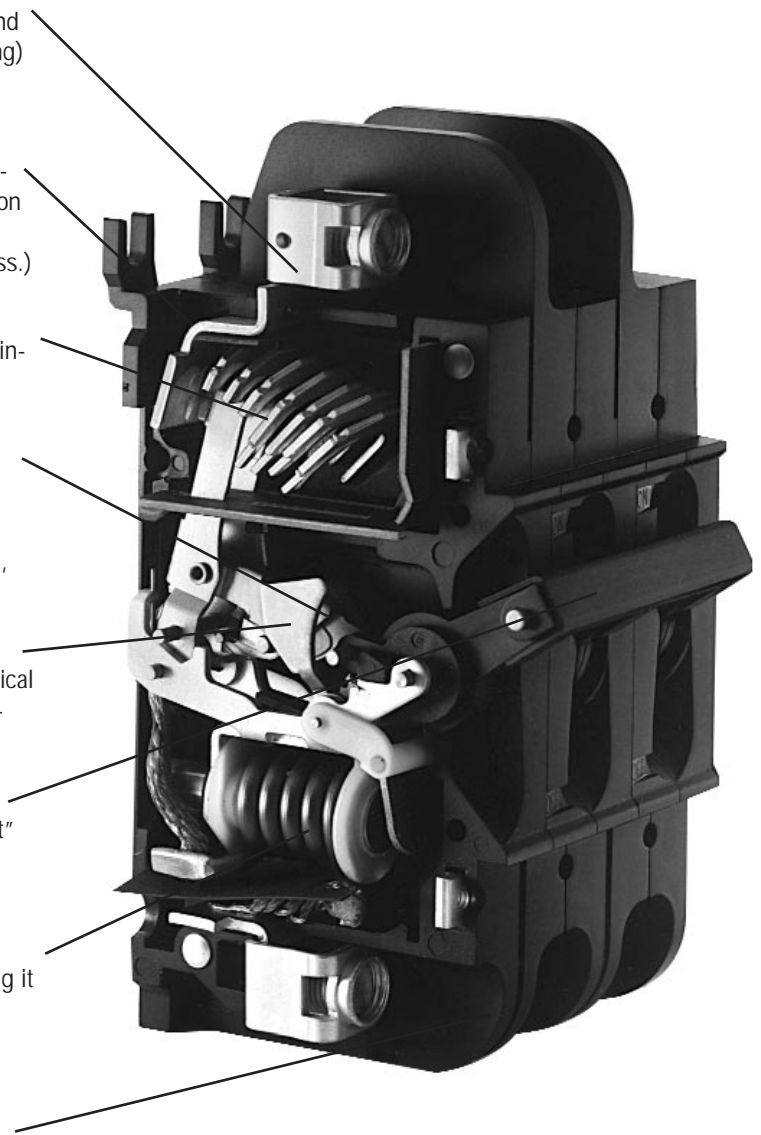

Internal Circuits for Protective and Control Applications

Circuit breakers are often overlooked as control elements in industrial circuit design. The seven constructions outlined below illustrate the broad range of possibilities currently available on standard products. When used singly or in combination, these special circuits allow breakers to become more meaningful members of modern control systems. Other designs are also available for more unusual applications. Consult HEINEMANN for assistance.

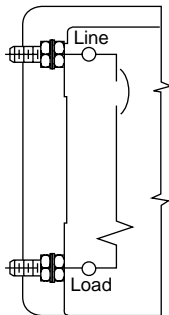

Series-Trip

In this conventional circuit breaker configuration, the sensing coil and contacts are wired in series with the line and load terminals.

This standard design is used in breakers that see duty as main switches and as short circuit protectors in supply-voltage wiring. They also provide overload protection for a wide variety of equipment and components such as transformers, solenoids and motors.

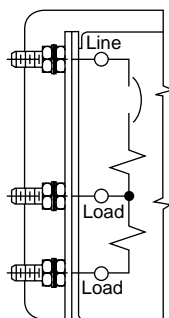

Dual Rating

This construction employs two concentrically wound sensing coils to provide two discrete current ratings in the same breaker. This permits the use of a single breaker to protect equipment designed to operate at two different current levels, or two different supply voltages, such as 6/12V DC or 110/220V 50/60 Hz. Certain limitations may govern application; consult HEINEMANN for assistance.

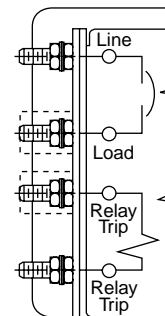

Relay-Trip

The relay-trip design provides a tripping coil that is actuated from a remote device (any control switch or even another circuit breaker). Because the relay-trip coil is isolated from the contact circuit, either control current or voltage may be employed to trip the breaker.

Relay-trip breakers are available with voltage-sensing or current-sensing coils, with or without intentional trip delay. (Non-delay is standard and will be provided unless otherwise specified.)

Voltage-sensing coils are usually designed for non-continuous duty, and provision must be made for de-energizing when the contacts are opened. Continuous-duty voltage coils, within certain limitations, can also be supplied. Consult HEINEMANN for parameters.

It is important to note that the current or voltage ratings of both coil and contact circuits should be specified separately.

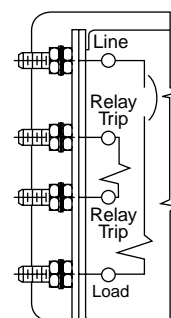

Dual Controlled (DuCon™)

In applications where over-current conditions and a separate (unrelated) voltage signal must be sensed, the general practice has been to use a two-pole breaker — one pole a series-trip and the other a relay- or shunt-trip.

For applications where space does not permit the use of a two-pole unit, the DuCon adds a small non-continuous duty voltage-sensing coil to a one-pole series-trip breaker, using either relay-trip circuitry for energizing from a source other than line voltage, or shunt/tap circuitry for operation on the same power source as that used in the overload protection circuit.

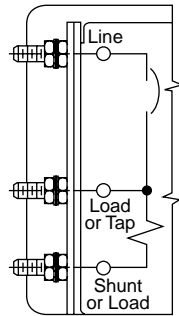

Shunt/Tap

The shunt/tap design allows remote tripping through appropriate circuit-closing contacts in a remote device. (On breakers rated 1A and below, the design can also be used to raise the breaker's trip point by shunting with an external resistor between the load and shunt terminals.) Unlike relay-trip models, shunt/tap breakers operate on the line voltage, rather than from a secondary power source.

It is important that the combined current through the load and the shunt/tap terminals not exceed the contact rating.

Although non-delay construction is standard with shunt/tap breakers, trip-delay response can also be provided.

Voltage coils are designed for non-continuous duty and must be de-energized when the contacts are open. (Within specific limitations, continuous-duty voltage coils are also available.)

High-Inrush

This is the ideal breaker configuration for protecting circuits likely to encounter high-inrush loads up to 30 times (3000%) rated current for one-half cycle at 60 Hz. Surges in this category are commonly found with startup of such devices as data processing distribution transformers and ferroresonant power supplies.

The high-inrush design eliminates nuisance tripping without the need for breaker derating, thereby providing closer tolerance circuit protection.

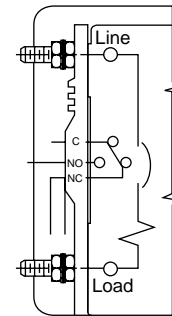

Auxiliary Switch

A miniature snap-action switch, mounted on the back of the breaker, is mechanically connected to the breaker's switching mechanism. Switching in conjunction with the breaker itself, the secondary switch can be used to activate logic functions, alarms, lights and other circuits.

The auxiliary switch is in the normal position (NO or NC) when the breaker is in the OFF position. Contact capacity is 10A at 125/250V (50/60 Hz), 4A resistive at 30V DC, and 2.5A inductive at 30V DC. Minimum operating voltage is 6V DC or V AC, and power 3V AC or DC. (Lesser voltages can also be accommodated. Contact HEINEMANN.)

A separate auxiliary alarm switch, actuated only by electrical tripping of the breaker, is also available.

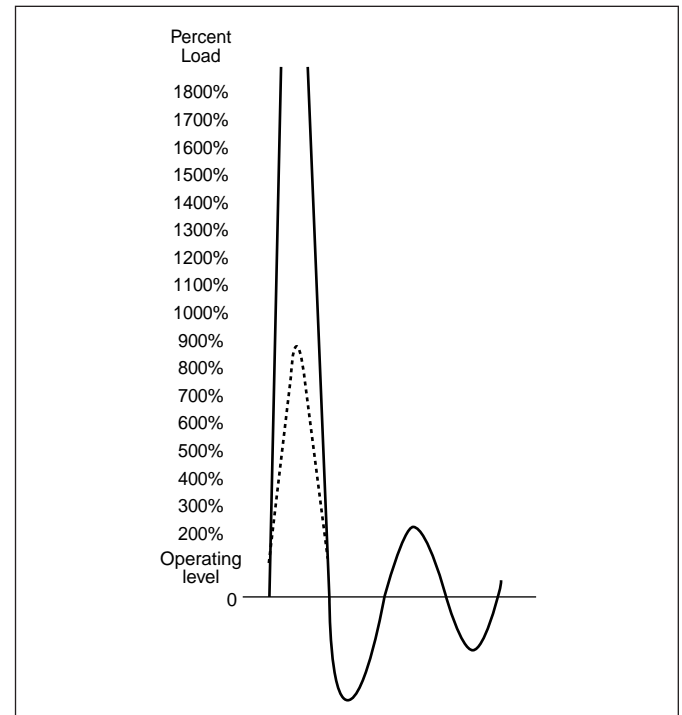

Construction Codes

The numbers in the upper left of the Internal Circuit boxes refer to the construction code numbers required for ordering. HEINEMANN offers circuit breakers for most equipment and branch circuit protection applications, with current ratings from 0.01 to 1200A.

Single and multiple
MIL-spec

Calibrated metering shunt
High-inrush

Time delay
UL/CSA/SEV/IEC/VDE requirements

Ask about other circuit constructions not shown on these pages, which may be available to suit your application requirements. For information on specific construction circuit breaker type combinations, contact HEINEMANN.

0 Switch — no sensing coil

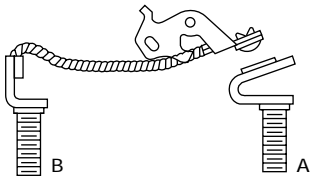

Used as disconnect switch

2 Series trip with auxiliary switch

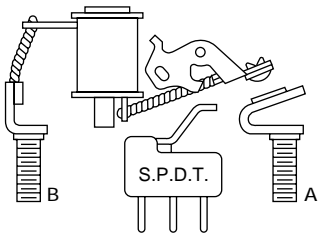

Auxiliary switch used as remote indicator to show breaker position

3 Series trip

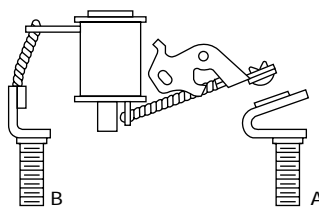

Standard circuit protection; coil in series with contacts

5 Shunt/tap

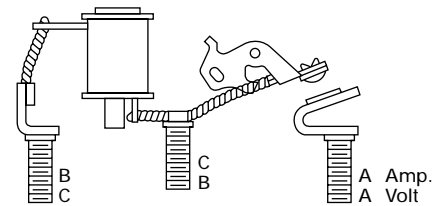

Controls two circuits from common source

6 Relay-trip

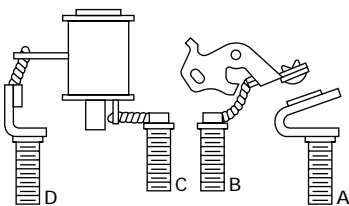

Controls two circuits from separate sources

7 Dual rating

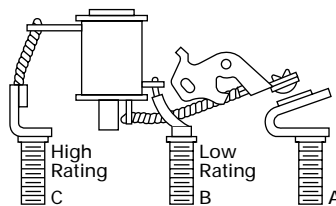

Allows two ampere ratings in one pole

8 Shunt plate

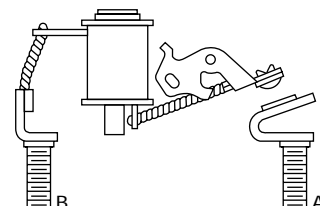

Allows circuit breaker to withstand high-inrush surges; eliminates nuisance tripping

9 Shunt plate with auxiliary switch

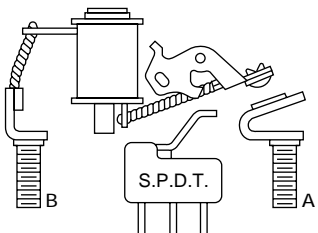

Used as remote indicator; withstands high-inrush surges

12 Switch with auxiliary switch

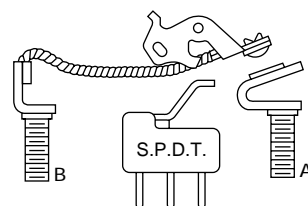

No sensing coil; features remote indicator

14 Series trip with double pole auxiliary switch

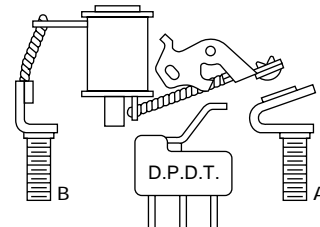

Remote indicating auxiliary switch with two separate circuits

15 Du-Con with shunt/tap voltage coil

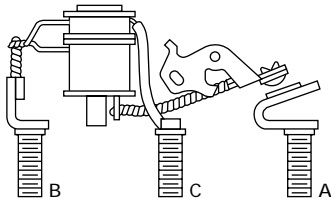

Controls two circuits, with voltage trip capability, from common voltage source

16 Du-Con with relay trip voltage coil

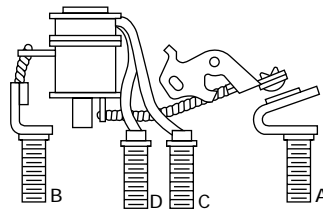

Controls two circuits, with voltage trip capability, from two separate voltage sources

20 Switch with double pole auxiliary switch

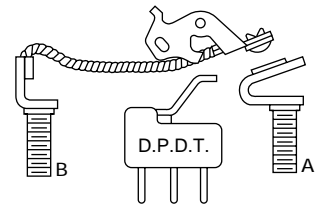

Remote indicating switch with two separate circuits

21 Shunt plate with double pole auxiliary switch

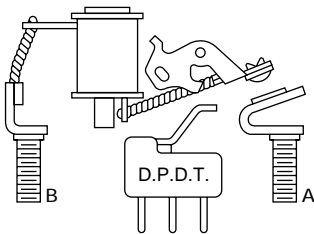

High-inrush surge capability with remote indicating auxiliary switches

22 Shunt/tap — shunt plate coil

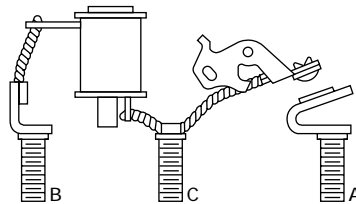

Controls two circuits from common source with high-inrush capability

23 Relay trip — shunt plate coil

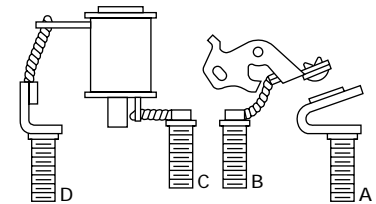

Controls two circuits from separate sources with high-inrush capability on one circuit

25 Du-Con with shunt/tap voltage coil

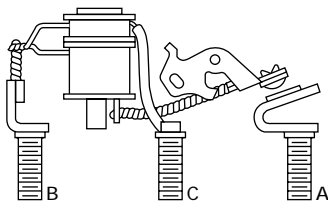

Controls two circuits, with voltage trip capability, from common voltage source; high-inrush capability

26 Du-Con with relay trip voltage coil

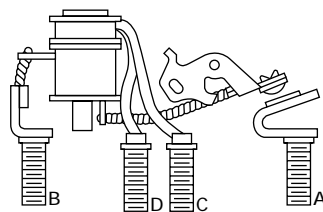

Controls two circuits, with voltage trip capability, from two separate voltage sources; high-inrush capability

27 Dual rating — shunt plate

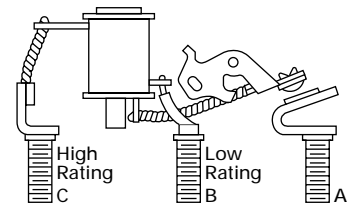

Allows multiple ampere ratings in one breaker; high-inrush capability

32 Shunt/tap — double shunt plate

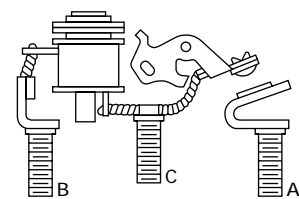

Controls two circuits from common source; provides extra (25x) high-inrush capability

33 Relay trip — double shunt plate

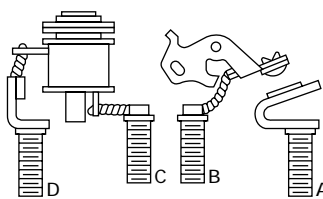

Controls two circuits from separate sources; provides extra (25x) high-inrush capability on one circuit

38 Series trip — double shunt plate

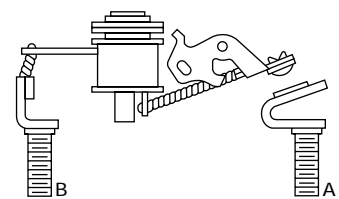

Provides extra (25x) high-inrush capability; coil in series with contacts

Other HEINEMANN Products

Interlocked Circuit Breakers

HEINEMANN Interlocked Circuit Breakers are designed to provide protection in industrial plants, hospitals and other applications where two sources of power are in use. On marine craft, it is used to prevent dockside and on-board power from being on simultaneously. To avoid this potentially hazardous situation, HEINEMANN has developed special circuit breakers which combine three functions into one device — hydraulic-magnetic overload protection, power switching and an interlock.

The interlock allows only one power source to be on at one time, although both can be off at the same time. This eliminates the need for a separate selector switch. Interlocked circuit breakers are available with current ratings from 0.01 to 100 amperes and from 100 to 250 amperes. Requires 4 pole minimum.



DM/S DIN Rail Mount Circuit Breakers

Easy to mount or detach. For process controls, industrial equipment and telecommunications systems using 35 mm DIN rail mounted components, HEINEMANN offers a versatile line of hydraulic-magnetic circuit breakers. DM/S breakers may be mounted or detached from the DIN rail without removing other breakers on the rail. They are supplied with industry standard screw clamp terminals. Eighteen different time-delay curves help assure an optimum match of the breaker to the application. An optional built-in auxiliary switch can be supplied for control or alarm purposes.

Ratings available from 0.02 to 50 amperes.

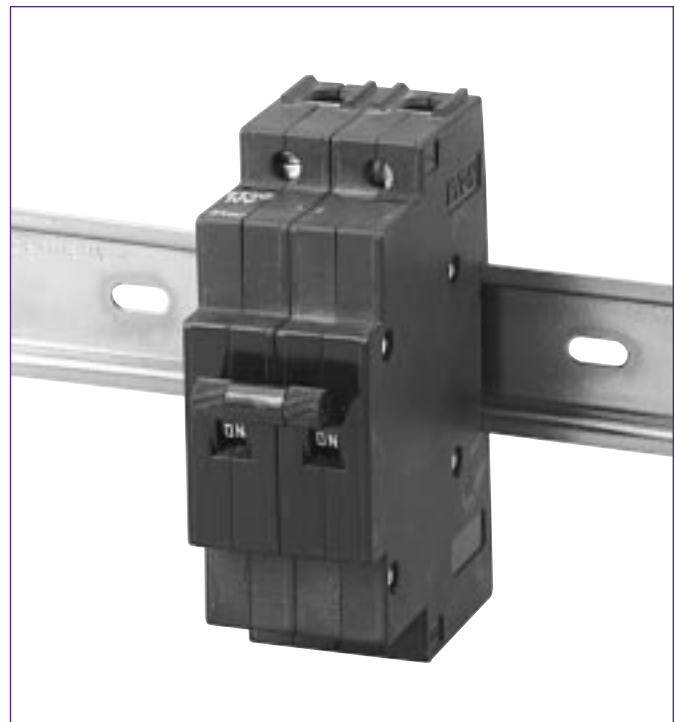

UL, CSA, VDE, IEC and SEV Tested Circuit Breakers

Circuit breakers and their equipment applications are commonly submitted to Underwriters Laboratories (UL) in the USA and Canadian Standards Association (CSA) for Canada.

As a specifier of circuit breakers, you may find test standards confusing. Part of this confusion results from the names given the testing services at UL. Breakers with 5,000A interrupting capacity (up to 100A, 240V AC rating) or 18,000A (up to 250A, 240V AC rating) can be UL listed to UL 489 or CSA certified as service entrance or branch circuit breakers. These are typically used where they are not backed by any other circuit-breaking device.

Breakers used as components in manufactured equipment should be "Recognized" under the UL Recognition Service (UL 1077), or CSA certified as components. Specifiers often ask for a "UL approved breaker" for their equipment when they require a "Recognized" component with the proper voltage and current ratings for their application.

World Approvals

There are various testing and certification organizations outside North America which grant approvals for circuit breakers and other electrical devices. Some organizations are independent, others may be government-directed. Several overseas approval granting organizations are indicated below.



Underwriters Laboratories accepts submittals from manufacturers all over the world of equipment including circuit breakers for investigation and follow-up using UL standards.

If the circuit breaker application is expected to be used in Europe, it may require examination by VDE, an approval authority for Germany. Standards of Switzerland, SEV, may also apply. IEC is a standards writing organization whose standards are widely accepted in many international markets. MITI is a Japanese standards organization. Other local or national standards may apply to products using circuit breakers.

For example, HEINEMANN Series AM/S and J/S circuit breakers have been tested under IEC 380 and VDE 0806, which cover safety of electrically energized office machines. The J/S breaker has also been tested under VDE performance standard 0660, whose requirements are widely accepted as suitable for circuit breakers regardless of the type of equipment with which they are used.

Since performance standards may vary for worldwide applications, it is suggested you consult HEINEMANN for your requirements.

MIL-spec Circuit Breakers

Various HEINEMANN circuit breakers qualify under MIL-C-55629 and MIL-C-39019. Consult HEINEMANN for details.

The HEINEMANN Limited Warranty

Seller warrants the goods covered by this Agreement to be free from defects in material and workmanship for a period specified (see right) from date of shipment to Buyer. This warranty is valid only if the goods are stored in a manner acceptable to Seller. This is a limited warranty limited to its terms. This warranty is void if the goods have been altered, misused, taken apart or otherwise abused. ALL OTHER WARRANTIES, EXPRESS OR IMPLIED, ARE EXCLUDED. THERE ARE NO IMPLIED WARRANTIES OF MERCHANTABILITY OR OF FITNESS FOR A PARTICULAR PURPOSE FOR GOODS COVERED BY THIS AGREEMENT.

Products manufactured by Eaton Corporation — Heinemann Products are warranted for a period of two (2) years from date of shipment. For complete terms and conditions of sale see CMCO Bulletin C-C 7.0.



Eaton Corporation
Commercial Controls Division
4201 N. 27th Street
Milwaukee, WI 53216
Phone: (800) 526-5476; Fax: (414) 449-6760
www.commercialcontrols.eaton.com

EATON